

Uchwyć z zabezpieczeniem pod plombę 4.417

Zabezpieczenie pod plombę 4.416

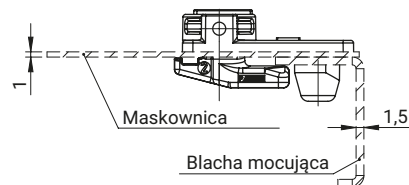

Pomocniczy rzut montażowy

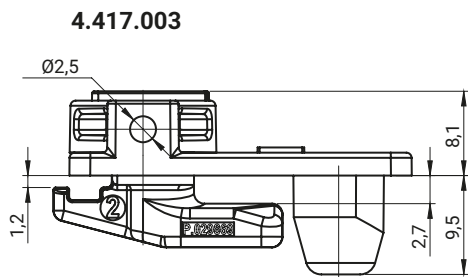
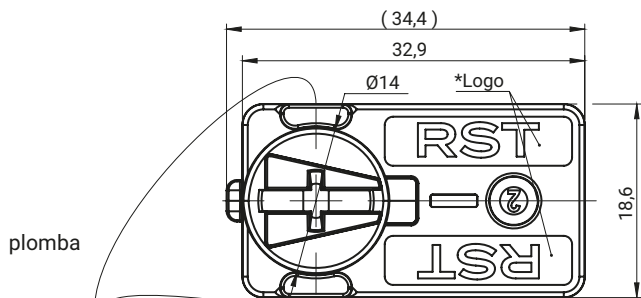

* Możliwość wykonania logo o wymiarach 16x3,5

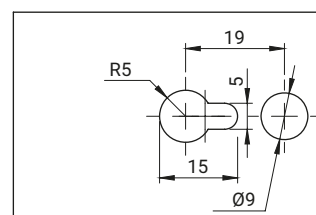

Otwory montażowe

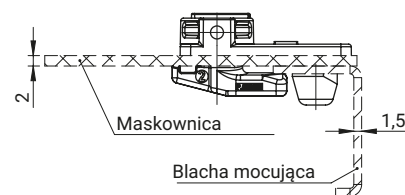
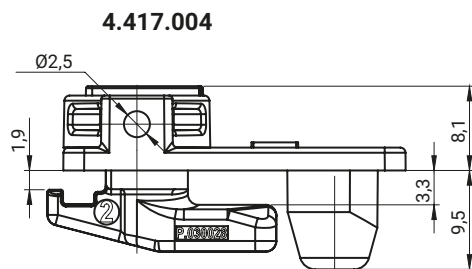

Pomocniczy rzut montażowy

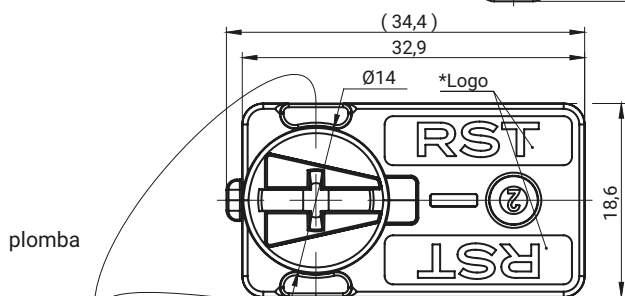

* Możliwość wykonania logo o wymiarach 16x3,5

* Uchwyć z zabezpieczeniem 4.417.003, 4.417.004 pakowany po 100 lub 500 szt.

| NR KATALOGOWY | DETAL | MATERIAL |
|---------------|-------------------------------------|--------------|
| 4.417.003 | Uchwyć z zabezpieczeniem pod plombę | Poliamid PA6 |
| 4.417.004 | | |

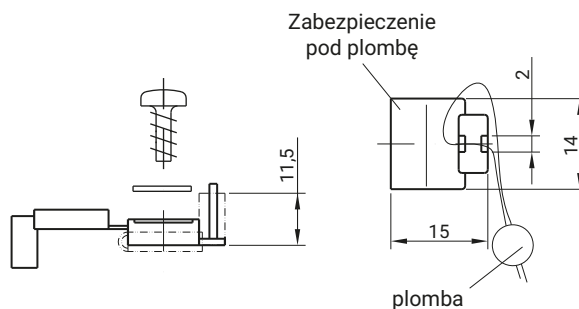
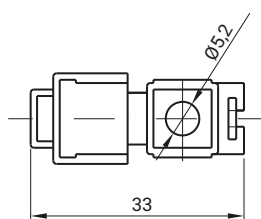

| NR KATALOGOWY | DETAL | MATERIAL |
|---------------|---------------------------|----------|
| 4.416.001 | Zabezpieczenie pod plombę | Poliamid |