

Holder with seal 4.417

Holder with seal 4.416

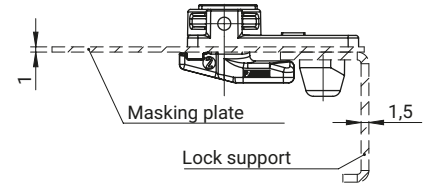

4.417.003

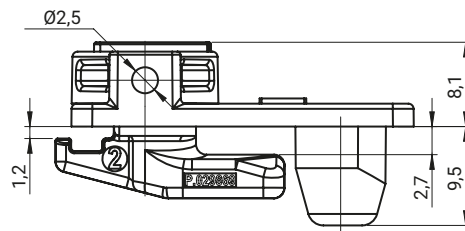

Auxiliary installation plan

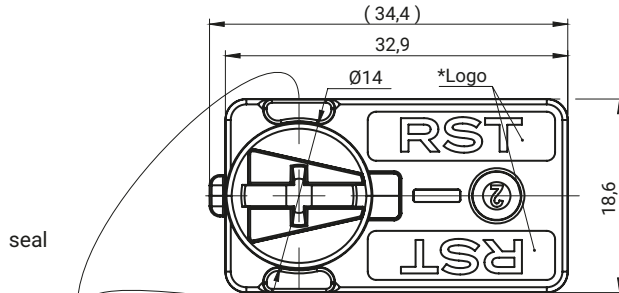

* Logo measuring 16x3.5 possible

4.417.004

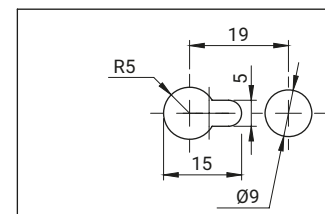
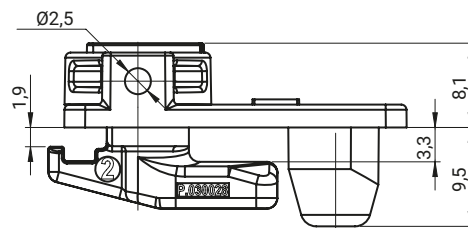

Mounting holes

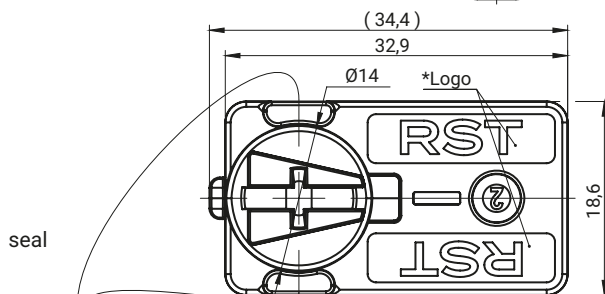

* Logo measuring 16x3.5 possible

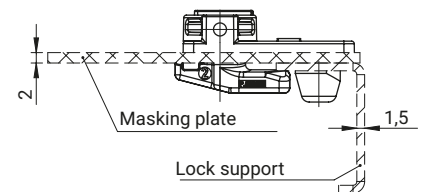

Auxiliary installation plan

* Handle with safety catch 4.417.003, 4.417.004 packaged in 100 or 500 pieces.

CATALOGUE NO.	NAME	MATERIAL
4.417.003	Holder with seal	Polyamide PA6
4.417.004		

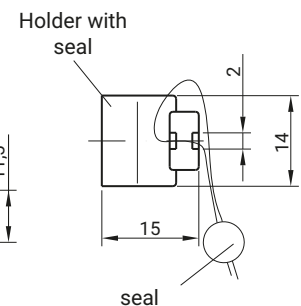
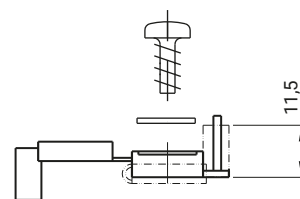
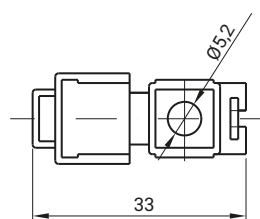

CATALOGUE NO.	NAME	MATERIAL
4.416.001	Holder with seal	Polyamide