

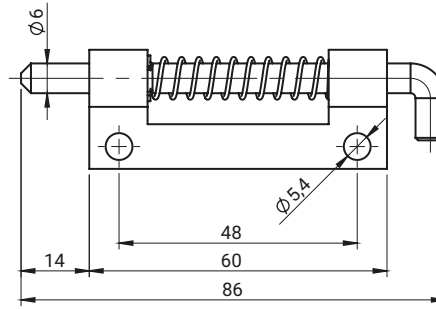
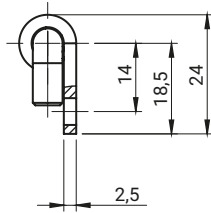
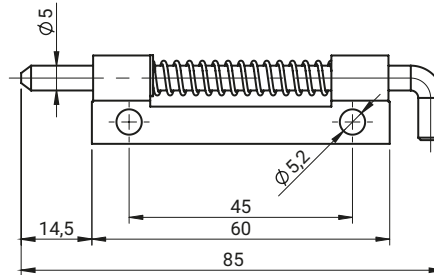
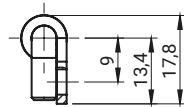
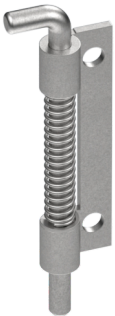
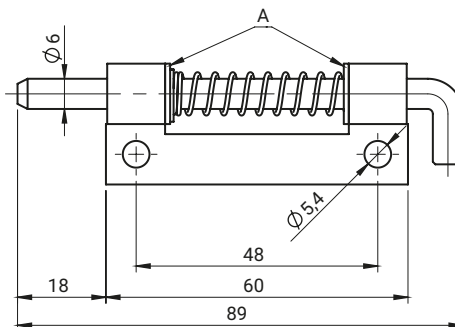
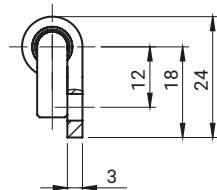

 stainless steel

CATALOGUE NO.	COMPONENTS	MATERIAL
3.ST20.004	Holder, Pin	Steel zinc plated
3.ST20.004SN	Holder, Pin	Stainless steel

 stainless steel

CATALOGUE NO.	COMPONENTS	MATERIAL
3.ST20.005	Holder, Pin	Steel zinc plated
3.ST20.005SN	Holder, Pin	Stainless steel

 stainless steel

A - slide bushings made of plastics

CATALOGUE NO.	COMPONENTS	MATERIAL
3.ST20.010	Holder, Pin	Steel zinc plated
	Plain bearing bush	POM
3.ST20.010SN	Holder, Pin	Stainless steel