

НОМЕР В КАТАЛОГЕ	МАТЕРИАЛ
3.ST209.001	Сталь оцинк
3.ST209.001SN	Нержавеющая сталь

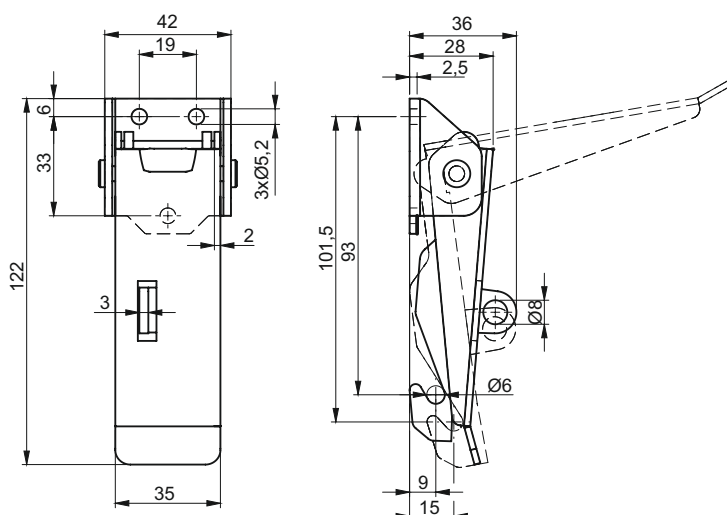

НОМЕР В КАТАЛОГЕ	МАТЕРИАЛ
3.ST211.001	Сталь оцинк
3.ST211.001SN	Нержавеющая сталь